

The Solid Choice™

2417

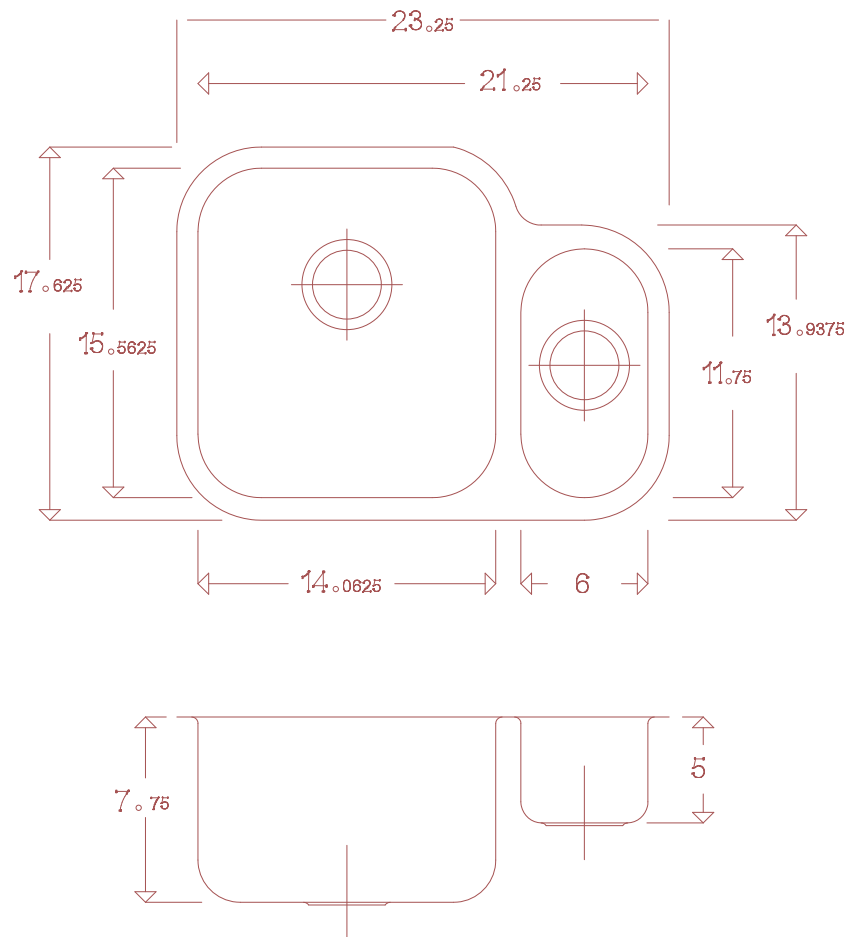

Fabrication Notes:

The countertop fabricator or manufacturer must check the template provided with the product or call Craftstone Products LLC at 423-332-3432.

Craftstone Products LLC is not responsible if the cutout is incorrect due to failure to check the template against the actual sink.

DXF available upon request,

www.CraftstoneProducts.com